

**TUMBLE-DRYER
TD534
AUTOREVERSE
ELECTRONIC
SENSOR**

INSTRUCTION BOOKLET

CONTENTS

Warnings	Page	3
Intallation	Page	4
Positioning	Page	4
Levelling	Page	5
Door reversal	Page	5
Electrical connections	Page	6
Use	Page	7
Control panel	Page	7
Use of controls	Page	7
Electronic and Time Controlled Programmes	Page	8
Useful hints	Page	8
Drying Programmes	Page	9
Drying	Page	10
Maintenance	Page	11
External cleaning	Page	11
Cleaning the door	Page	11
Cleaning the filter	Page	11
Servicing	Page	11
Peace of mind for twelve months	Page	12

TECHNICAL SPECIFICATIONS

DIMENSIONS	Height	85 cm (33.5")
	Width	60 cm (23.6")
	Depth	57 cm (22.4")
ELECTRICAL CONNECTION	Voltage	220-240 V/50 Hz
	Max. power absorbed	2650 W (13A)
DRYING CAPACITY	Cotton, linen	5 kg (11 lb)
	Synthetics	2 kg (4.5 lb)

CE This appliance complies with the following E.E.C. Directives:
- 73/23 EEC of 19.2.73 (Low Voltage Directive) and subsequent modifications;
- 89/336 EEC of 3.5.89 (Electromagnetic Compatibility Directive) and subsequent modifications.

Stacking kit

A special stacking kit is available through your dealer, to enable the mounting of the dryer on top of your washing machine.

WARNINGS

It is most important that this instruction book should be retained with the appliance for future reference. Should the appliance be sold or transferred to another owner, or should you move house and leave the appliance, always ensure that the book is supplied with the appliance in order that the new owner can get to know the functioning of the appliance and the relevant warnings.

These warnings have been provided in the interest of safety. You **MUST** read them carefully before installing or using the appliance.

INSTALLATION

- Any electrical work required to install this appliance should be carried out by a qualified electrician or competent person.
- Make sure that the appliance does not stand on its electrical supply cable.
- If the machine is situated on a carpeted floor, please adjust the feet in order to allow air to circulate freely.
- This tumble dryer is designed to be vented through to the open air. It should have its own ventilation system which should not be joined with any other ventilation system connected to any other appliance.

USE

- Always unplug the appliance after use.
- Clothes which are dripping wet should not be placed in the dryer.
Always load well spun laundry. The higher the spin speed, the lower the electricity consumption and the shorter the drying times.
- Never tumble dry items that have been in contact with chemicals such as dry cleaning fluid. These are of a volatile nature and could cause an explosion.
- As some bulky items such as duvets and eider-downs should be dried in large commercial machines because of their bulk, check with the manufacturer of the item if it is suitable for drying in a domestic machine, even if the dry weight of the item is within the limit advised.
- Always check that no cigarette lighters have been left in pockets.
- Leave the porthole door slightly ajar when not in use to preserve the door seal.
- The fluff filter must be cleaned after every use.
- Do not operate the appliance with a damaged filter as this may cause a fire.
- Do not overload the appliance.
- Do not allow fluff to accumulate around the dryer.

SERVICE/REPAIR

- Under no circumstances should you attempt to repair the machine yourself. Repairs carried out by inexperienced persons may cause injury or serious malfunctioning. Refer to your local Zanussi Service Centre. Always insist on genuine Zanussi spare parts.

GENERAL SAFETY

- It is dangerous to modify or try to modify the specifications of this appliance in any way.
- This appliance is designed to be used by adults. Children should not be allowed to touch the controls or play with the product.
- Pets and small children may climb into tumble dryers. Check your appliance each time before use.

ENVIRONMENT PROTECTION

- The materials used on this appliance marked with the symbol  are recyclable. This means that they can be recycled by disposing of them properly in appropriate collection containers.
- If you take your appliance to a refuse disposal site, cut off the power cable flush with the appliance to avoid the danger of the appliance being re-used, and disable the door catch to prevent children becoming trapped inside.

INSTALLATION

Positioning

The appliance may be placed in any room, provided the following precautions are taken.

The appliance expels hot, very moist air. The rest of the house must be able to easily absorb this moisture. Normally, absorption is only possible in houses where there is very little humidity. Otherwise, the room must have ventilation towards the outside; generally, an open door or window is enough.

The capacity of the venting circuit must be at least 150 m³/hour. Check that the air inlet and outlet vents are unobstructed.

The best way of evacuating the moisture is through a vent hose to the outside of the building. Use the special 100 mm diameter flexible hose supplied with the appliance connected to one of the air outlet vents with the collar supplied.

The unused outlets must be covered.

Never connect the air vent hose into an existing discharge pipe or duct, as this could be dangerous, might disturb neighbours and could cause the dryer to malfunction.

This product is supplied with a 2.50 metre vent hose, although the maximum length of the vent hose may be:

- 4 metres with no bends, or
- 2 metres with 2 bends.

Advice: If the hose is long and the room temperature low, the moisture might condense to water inside the hose. **This is an unavoidable natural phenomenon.** To prevent this water from lying in the hose or flowing back into the tumble dryer, it is advisable to drill a small hole (dia. 3 mm) in the lowest point of the hose and to place a small container below it. (See picture, point A).

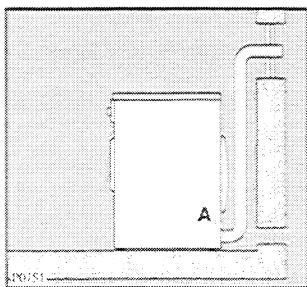

Connect the other end of the hose to an opening in a door or window. Fit a suitable shield or point the hose downwards to prevent any rain water and wind from getting in.

Rain and wind shields for placing over openings usually consist of valves or movable flaps. Periodically check the shield since strong winds and other factors (rust, dirt) can sometimes prevent it from opening, so causing problems with air venting.

If you use a rain shield, check that the openings in it are large enough to allow air to escape. Openings which are too small restrict the flow of air.

Problems can be encountered in rooms fitted with a very powerful central extractor fan. If you find that drying times are too long, switch off the extractor or close its grille whilst the tumble dryer is in use.

A highly effective solution is to simply poke the vent hose through a window or skylight. This might however cause problems in winter because the dryer will draw in very cold (and often also very damp) air through the open window, so increasing drying times and leading to very high energy consumption.

If the dryer is fitted next to kitchen units, make sure that the vent hose is not squashed. If the hose is partially squashed, drying efficiency will be reduced, resulting in longer drying times and higher energy consumption.

If the hose is completely squashed, the safety cut-outs with which the machine is fitted may operate.

Condensation discharge through the vent hose

Condensation may be discharged either through a vent outlet provided at the back or through the left or right side outlet.

The vent hose collar is placed in the rear vent outlet.

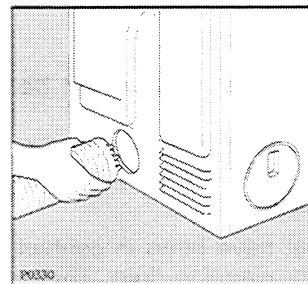

Remove the collar by pulling it out of the vent outlet. Screw the collar to the vent hose.

Fit the hose into the required vent outlet and stop the unused outlets with the covers provided for such a purpose.

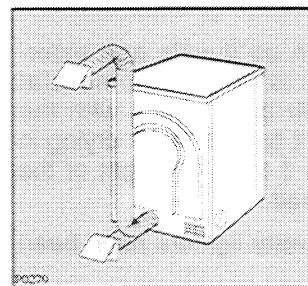

The vent hose must not contain more than two bends when it is placed in position for operation.

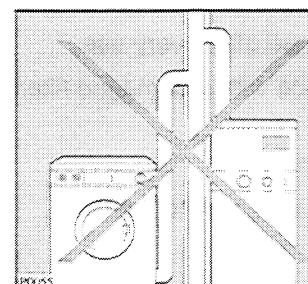

You should **NOT** connect the flexible vent hose to, for example, a chimney or flue pipe designed to carry the exhaust from a fuel burning heating appliance.

The tumble dryer must be installed in a clean place, where dirt does not build up.

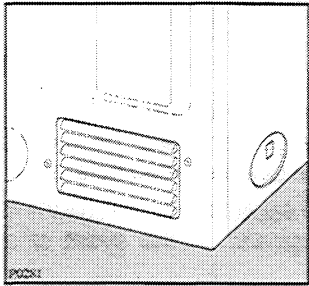

Make sure there are no obstructing items or material near the air-intake louvres provided at the back (e.g. paper, rags etc.).

Important

When operating the tumble dryer, the room temperature must not exceed 35°C, as it may affect the performance of the appliance.

To save energy, the room temperature should not be lower than +15°C.

Levelling

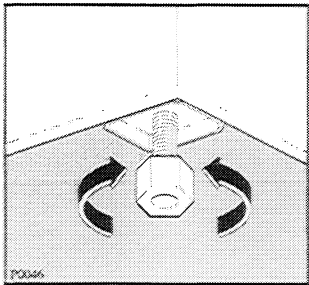

Level the tumble dryer into place by screwing or unscrewing the front feet as required.

Accurate levelling will keep vibration and noise to a minimum when the dryer is in use.

Door reversal

To make it easier to load or unload the laundry the door can be reversed.

This operation must be carried out by qualified personnel.

Operate as follows:

- Remove the door by unscrewing the two screws (1) fastening the hinge to the cabinet (Fig. A).
- Remove the safety catch (2) and the plug (3) by bending the two fastening tags (Fig. A).
- Refit the safety catch (2) and plug (3) on the door by reversing their positions (Fig. B).
- Remove the plastic plate (4) by unscrewing the two fastening screws (Fig. A)
- Refit the plastic plate (4) on the opposite side (Fig. B)
- Refit the door by screwing in the two screws (1) which fasten the door to the cabinet (Fig. B).

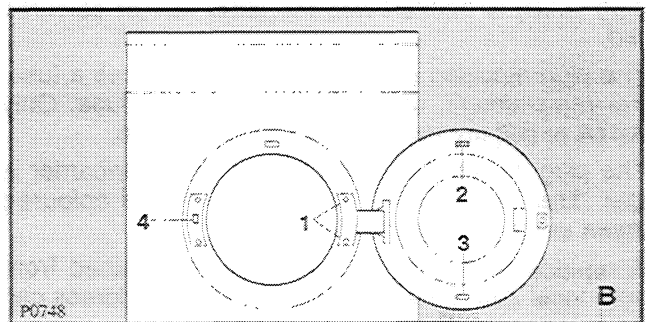
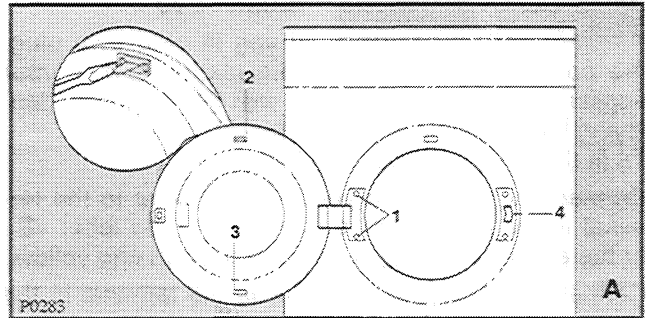

Electrical Connections

WARNING: THIS APPLIANCE MUST BE EARTHED.

The manufacturer declines any liability should this safety measure not be observed.

If the plug that is fitted to your appliance is not suitable for your socket outlet, it must be cut off, and the appropriate plug fitted.

Remove the fuse from the cut off plug. The cut off plug should then be disposed of to prevent the hazard of electric shocks, in case it should be plugged into a 13 Amp socket in another part of your home.

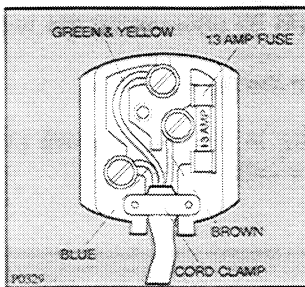

IMPORTANT

The wires in the mains lead are coloured in accordance with the following code:

Green and Yellow - Earth

Blue - Neutral

Brown - Live

If you fit your own plug, the colours of the wires in the mains lead of your appliance may not correspond with the markings identifying the terminals in your plug.

To fit the plug, proceed as follows:

Connect the green and yellow (earth) wire to the terminal in the plug which is marked with the letter «E» or the earth symbol \perp , or coloured green and yellow.

Connect the blue (neutral) wire to the terminal in the plug which is marked with the letter «N» or coloured black.

Connect the brown (live) wire to the terminal in the plug which is marked with the letter «L» or coloured red.

The plug moulded on to the lead incorporates a fuse. For replacement, use a 13 Amp BS1362 fuse. Only ASTA or BSI approved fuses should be used.

The plug must not be used if the fuse cover/carrier is lost. The cover/carrier is indicated by the coloured insert at the base of the plug.

A replacement cover/carrier must be obtained from your local Zanussi Service Centre whose address can be found in the Customer Care Leaflet accompanying this manual.

Avoid connecting the tumble dryer to the same socket as your washing machine (or any other appliance) by means of an adaptor. Have an extra socket installed if necessary, by a qualified electrician.

Note

Installation, and, in particular, connection to the electric mains and to the discharge vent must be carried out by a competent person or qualified electricians.

Please ensure that when the appliance is installed it is easily accessible for the engineer, in the event of a breakdown.

Control panel

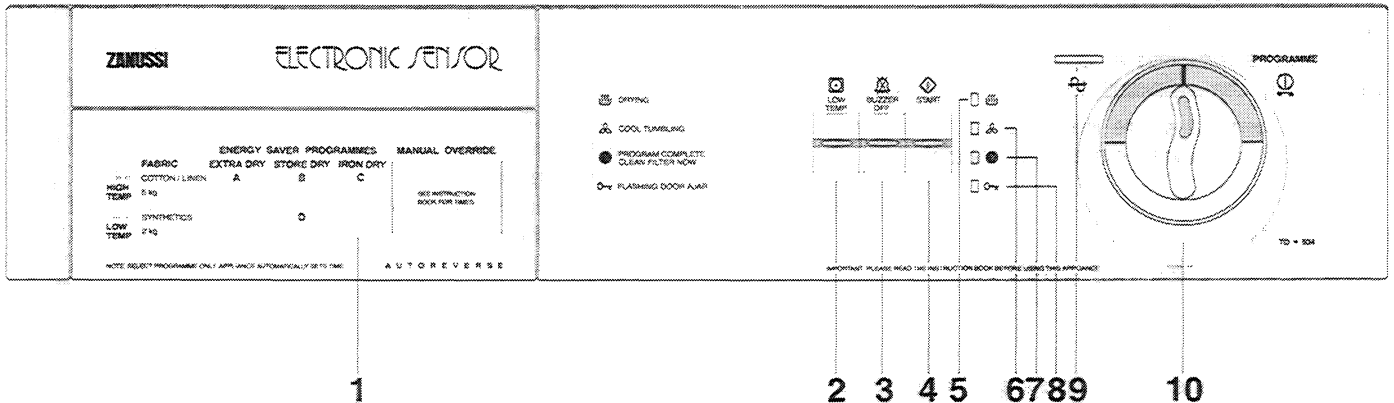

USE OF CONTROLS

1 Programme Chart

This will help you to select the correct programme for drying.

2 Low Temperature Button

Press this button to reduce the temperature when drying particularly delicate items.
To be used specially when drying synthetics with the time controlled programme.

3 Buzzer Off Button

Press this button if you do not wish the buzzer to ring during the «anti-crease» phase.

4 Start Button

Press this button to start the selected drying programme.
 If the door is opened during drying, this button has to be depressed after closing the door to allow the programme to continue.

5 Drying Light

This light (green) indicates that the machine is performing the drying programme.

6 Cool Tumbling Light

This light (green) will illuminate when the cooling phase is in operation. This starts 9 minutes before the end of drying to prevent any creasing or crumpling of fabrics.

7 Programme Complete & Clean Filter Now Light

This light (red) comes on at the end of the drying programme and remains alight until the door is opened.

This light will also remind you that the filter should be cleaned at the end of each drying cycle.

8 Open Door Light

This light (red) flashes when the door is opened or not well closed.

9 Mains-On Light

This lights up when the machine starts operating and goes out when the programme selector dial is turned to «0».

10 Programme Selector Dial

To set the machine to the selected programme or time, turn the dial until the **letter** or the **time** you want coincides exactly with the pointer.

Electronic Controlled Programmes (Energy Saver Programmes)

These operate by means of dampness sensors.

All you have to do is to set the selector dial for the programme required A, B, C or D and the laundry will be dried to the selected degree of dryness.

The following are the degrees of final drying which can be obtained with electronic control:

▪ Extra Dry

Ideal for bathrobes, bath towels etc.

▪ Store Dry

Suitable for items which you want to put away without ironing, for example towels and non-iron fabrics.

▪ Iron Dry

Suitable for items which need ironing.

▪ Synthetics (store dry)

Suitable for delicate articles which do not need ironing.

Time Controlled Programmes

The selector dial incorporates a drying cycle up to 90 minutes.

The selected time can be extended when the original programme is completed, by resetting the knob for a further period of drying.

It is better to select a time which is too short and then set the dial for a further period if necessary.

Select the drying time with the help of the programme guide.



Remember that during the last 9 minutes of the operation, the heat is cut off in order to carry out a fabric cooling phase, which prevents any creasing or crumpling of the fabrics.

If you dry synthetics, switch on the **LOW TEMP. button** . In this case a longer drying time should be selected.

Useful hints

- Try to load to the maximum capacity of the machine as small loads are uneconomical. For information, here is a list of the average weights of some common laundry items.

Sheet	700 - 1000 g
Tablecloth	400 - 500 g
Kitchen towel	70 - 120 g
Table napkin	50 - 100 g
Towelling hand towel	150 - 250 g
Bathrobe	1000 - 1500 g
Man's shirt	200 - 300 g
Pillowcase	100 - 200 g
Man's pyjamas	400 - 500 g
Ladies' nightdress	200 - 250 g

- Never tumble dry the following:
Particularly delicate items such as net curtains, woollen, silk, fabrics with metal trim, nylon tights, bulky materials such as anoraks, blankets, eider-downs, sleeping bags, feather quilts and any items containing rubber foam or materials similar to rubber foam.
- Always follow the instructions on garment labels.
 -  tumble dry normal (high temperature)
 -  tumble dry delicate (low temperature)
 -  do not tumble dry
- Close pillowcases and covers with fasteners to prevent small laundry items getting tangled inside them. Close press studs, zips and hooks and tie belts and apron strings.
- Sort laundry according to type and degree of drying required.
- Do not over-dry laundry, this avoids creasing and saves energy.
- Avoid drying dark clothes with light coloured fluffy items such as towels as they could attract the fluff.
- Remove the laundry when the dryer has finished drying.
- To avoid a static charge when drying is completed, use either a fabric softener when you are washing the laundry or a fabric conditioner specifically for tumble dryers.

Laundry Shrinkage



Certain fabrics such as woollens and silks are generally not suitable for tumble drying. Due to the structure of some woollen garments which are recommended for tumble drying, shrinking could still occur, but once the garment is worn again, it should regain its shape.

Starched Laundry

Starched laundry can also be dried in the tumble dryer. Make sure that the time selected is for iron dry. After completion of the programme wipe out the drum with a damp cloth and dry to remove any traces of starch.

Drying programmes



Electronic Controlled Programmes (Energy Saver Programmes)

Type of laundry and label on articles	Degree of drying required	Quantity	Selector dial setting
Cotten & linen 	Extra dry		A
	Store dry	5 kg	B (*)
	Iron dry		C (*)
Synthetics 	Store dry	2 kg	D (*)

(*) According to CEI 1121 standards.

Programme «B» is the reference programme for the Energy Label according to the article 2, paragraph 1 of the ECC Directive 92/75.

Time Controlled Programmes - Cotton and Linen

Degree of drying required and label on articles	Degree of spin given	Quantity	Selector dial setting
Store dry 	800-1000 rpm	5 kg	75-90 mins
		2 kg	60-75 mins
	1000-1200 rpm	5 kg	60-75 mins
		2 kg	45-60 mins
Iron dry 	800-1000 rpm	5 kg	60-75 mins
		2 kg	45-60 mins
	1000-1200 rpm	5 kg	45-60 mins
		2 kg	30-45 mins

Time Controlled Programmes - Synthetics: switch on pushbutton

Degree of drying required and labels on articles	Degree of spin given	Quantity	Selector dial setting
Store dry 	Short spin at 650 rpm	2 kg	45-60 mins
		1 kg	30-45 mins
		0.5 kg	20 mins

Never overfill the drum (do not load large quilts, for example).

The laundry must be suitably spin dried in your washing machine before being placed in the tumble dryer (500rpm minimum).

Drying times vary according to:

- The type of laundry
- The size of the load
- The degree of spinning prior to drying

Drying

1 Load the laundry

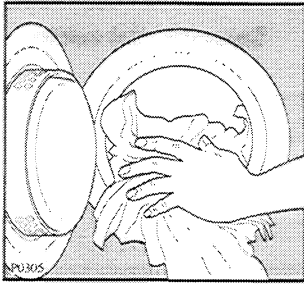

Open the door by pulling it outward.

Load the items one at a time, shaking them out loosely and close the door.

Please check the laundry does not get caught between the door and filter.

2 Select the drying time or the drying programme

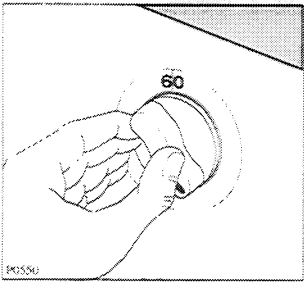

Turn the selector dial to the desired programme or time.

3 Select the required option

Depress Buzzer Off and/or Low Temp. Button, if you have to dry synthetics with a time controlled programme.

4 Start the machine

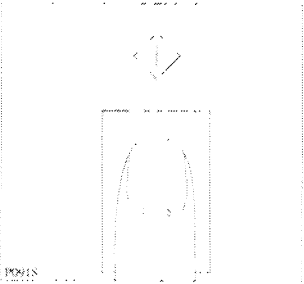

Depress START button, the mains-on light illuminates and the machine starts operating.

To change a programme already in progress, turn the selector dial to «0», select the new programme and then depress START button.

5 When drying is completed

The machine stops automatically.

If after a Time Controlled Programme the laundry is still too damp, select a further brief drying time, bearing in mind that during the last 9 minutes the dryer carries out the cooling phase.

Release the button(s).

Turn the selector dial to «0», the mains-on light goes out.

Antcrease phase

If you do not remove the laundry at the end of the programme, the machine will carry out automatically the «antcrease» phase which lasts approx 30 mins. During this period the drum will rotate at regular intervals to avoid creasing and the buzzer will sound for 1 second every 10 seconds, unless you have depressed the BUZZER OFF button.

To remove the laundry during this phase it is necessary to switch the machine off by turning the selector dial to «0».

Clean the filter after every drying programme. A clean filter ensures correct functioning of the appliance.

MAINTENANCE

Important

You must **disconnect** the appliance from the electricity supply, before you can carry out any cleaning or maintenance work.

External cleaning

Use only soap and water and then dry thoroughly.

From time to time, apply a little wax furniture cream with a soft cloth.

Important: do not use methylated spirit, diluents or similar products.

Cleaning the door

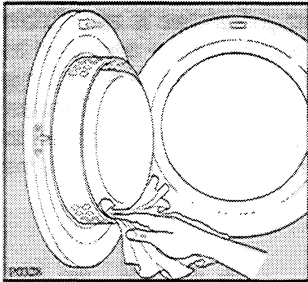

Clean periodically the interior part of the door to remove any fluff. Accurate cleaning ensures correct drying.

Cleaning the filter

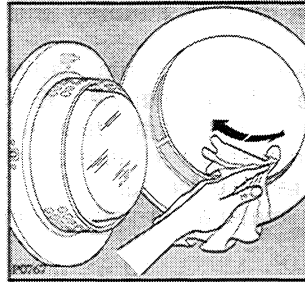

Your dryer will only function well if the filter is clean.

The filter collects all the «fluff» which accumulates during drying and it must therefore be cleaned at the end of each programme with a damp cloth.

The filter cannot be removed.

It is perfectly normal for fluff to accumulate in the filter during drying. In fact, even fabrics dried in the open air lose their fibres, but we do not notice it.

SERVICING

Before contacting your local Zanussi Service Centre, please make the following checks:

The dryer does not start up

- The door is open
- The plug is not fitted into the wall socket
- There is no electricity supply from the wall socket
- The programme selector dial is not set correctly
- The START button has not been depressed

The dryer does not dry properly

- The filter is clogged
- Insufficient drying time
- Excessive laundry load
- The dryer is not correctly installed

If, after the above checks, there is still a fault, call your local Zanussi Service Centre.

Please make sure you give the model and serial number of the appliance.

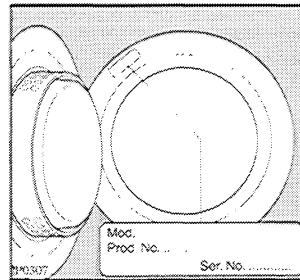

This information can be found on the rating plate (see picture) or on the guarantee card.

Original spare parts can be purchased from Zanussi Service Centres.

In-guarantee customers should ensure that the above checks have been made as the engineer will make a charge if the fault is not a mechanical or electrical breakdown.

Please note that proof of purchase is required for any in-guarantee service calls.

PEACE OF MIND FOR TWELVE MONTHS

Zanussi standard guarantee conditions

This guarantee is in addition to your statutory and other legal rights.

We, Zanussi Ltd., undertake that if, within twelve months of the date of the purchase, this ZANUSSI appliance or any part thereof is proved to be defective by reason only of faulty workmanship or materials, we will, at our option, repair or replace the same **FREE OF ANY CHARGE** for labour, materials or carriage on condition that:

- The appliance has been correctly installed and used only on the electricity supply stated on the rating plate.
- The appliance has been used for normal domestic purposes only, and in accordance with the manufacturer's operating and maintenance instructions.
- The appliance has not been serviced, maintained, repaired, taken apart or tampered with by any person not authorised by us.

All service work under this guarantee must be undertaken by a Zanussi Service Centre.

Home visits are made between **8.30am** and **5.30pm** Monday to Friday. Visits may be available outside these hours in which case a **premium** will be charged.

Any appliance or defective part replaced shall become our property.

Exclusions

This guarantee does not cover:

- Damage or calls resulting from transportation, improper use or neglect, the replacement of any light bulbs or removable parts of glass or plastic.
- Costs incurred for calls to put right machines improperly installed or calls to machines outside the United Kingdom.
- Appliances found to be in use within a commercial or similar environment, plus those which are subject to rental agreements.
- Products of Zanussi manufacture which are NOT marketed by Zanussi Ltd.
- EU Countries - The standard guarantee is applicable but subject to the owner's responsibility and cost to ensure the appliance meets the standards set by the country to which the product is taken. The Zanussi company in the country concerned will be pleased to advise further. Sight of your purchase receipt will be required by them.